

Graphic Solutions

Decorative Window Films



Engineered to Perform Better™





ORAFOL Europe GmbH

Headquarters and production facility

ORAFOL is one of the world's leading manufacturers of innovative self-adhesive graphic films, reflective materials and adhesive tape systems. The international ORAFOL GROUP is headquartered just outside the city gates of Berlin, in Oranienburg.

ORAFOL's Worldwide Locations

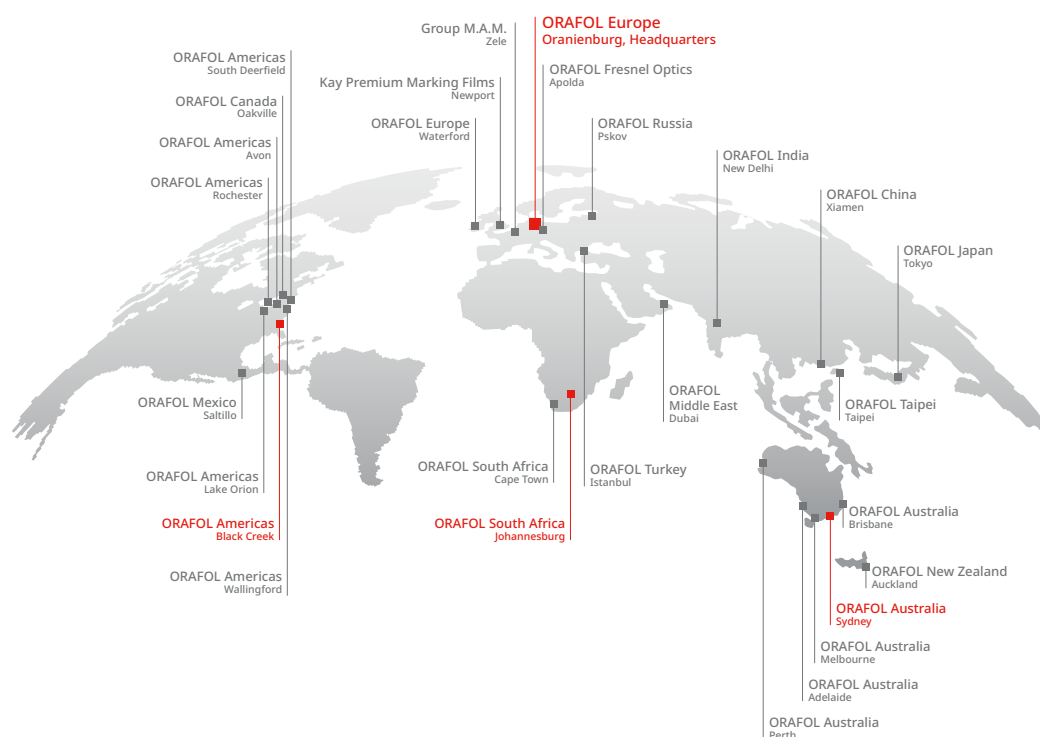

Index

Decorative Window Films

Page	List of contents
4	ORAFOL® Decorative Window Films
5	ORACAL® W001 White stripes of 4mm, Interior Design
6	ORACAL® W014 White squares of 20mm, Interior Design
7	ORACAL® UV05 Frosted stripes of 35mm, Interior Design
8	ORACAL® G002 Grey stripes of 10mm, Interior Design
9	ORACAL® W002 White stripes of 10mm, Interior Decoration
10	ORACAL® W018 White cocoon, Interior Design
11	ORACAL® W004 White stripes of 30mm, Interior Design
12	ORACAL® UV10 Frosted stripes of 5mm and 35mm, Interior Design
13	ORACAL® UV11 Frosted squares of 44mm, Interior Design
14	ORACAL® WM20 White Matt, Interior Design
15	ORACAL® DX01 Casual White, Interior Design
16	ORACAL® DX02 White Web, Interior Design
17	ORACAL® DX03 White Dots, Interior Design
18	ORACAL® DX04 Decreasing Dots, Interior Design
19	ORACAL® DX05 Gradient Dots, Interior Design
20	ORACAL® DX06 White & Grey Diamonds, Interior Design
21	ORACAL® 8300 Transparent Cal
22	ORAJET® 3352F Optical Clear Film
22	ORAJET® 3952F Optical Clear Film
23	ORAJET® 3851 Digital Printing Film
24	ORACAL® 8510 Etched Glass Cal
24	ORACAL® 8510 RA Etched Glass Cal – with RapidAir® Technology
25	ORACAL® 8530 Etched Glass Cal
26	ORACAL® 8710 Dusted Glass Cal
27	ORACAL® 8810 Frosted Glass Cast

ORACAL Decorative Window Films;

ORACAL Decorative Window Films offer a tremendous cost advantage in comparison to etched glasses made in traditional methods. This product range includes window films that are developed for long term use and suitable for large size graphic projects.

ORACAL Decorative Window Films can be used on acrylic plastic sheets, windows of shops, offices, lobbies, restaurants and conference rooms. ORACAL Decorative Window Films are also used on windows, glass doors and separators in laboratories and hospitals for privacy concerns.

These products provide glass design options of highest quality, without changing the glass structure or blocking sunlight.

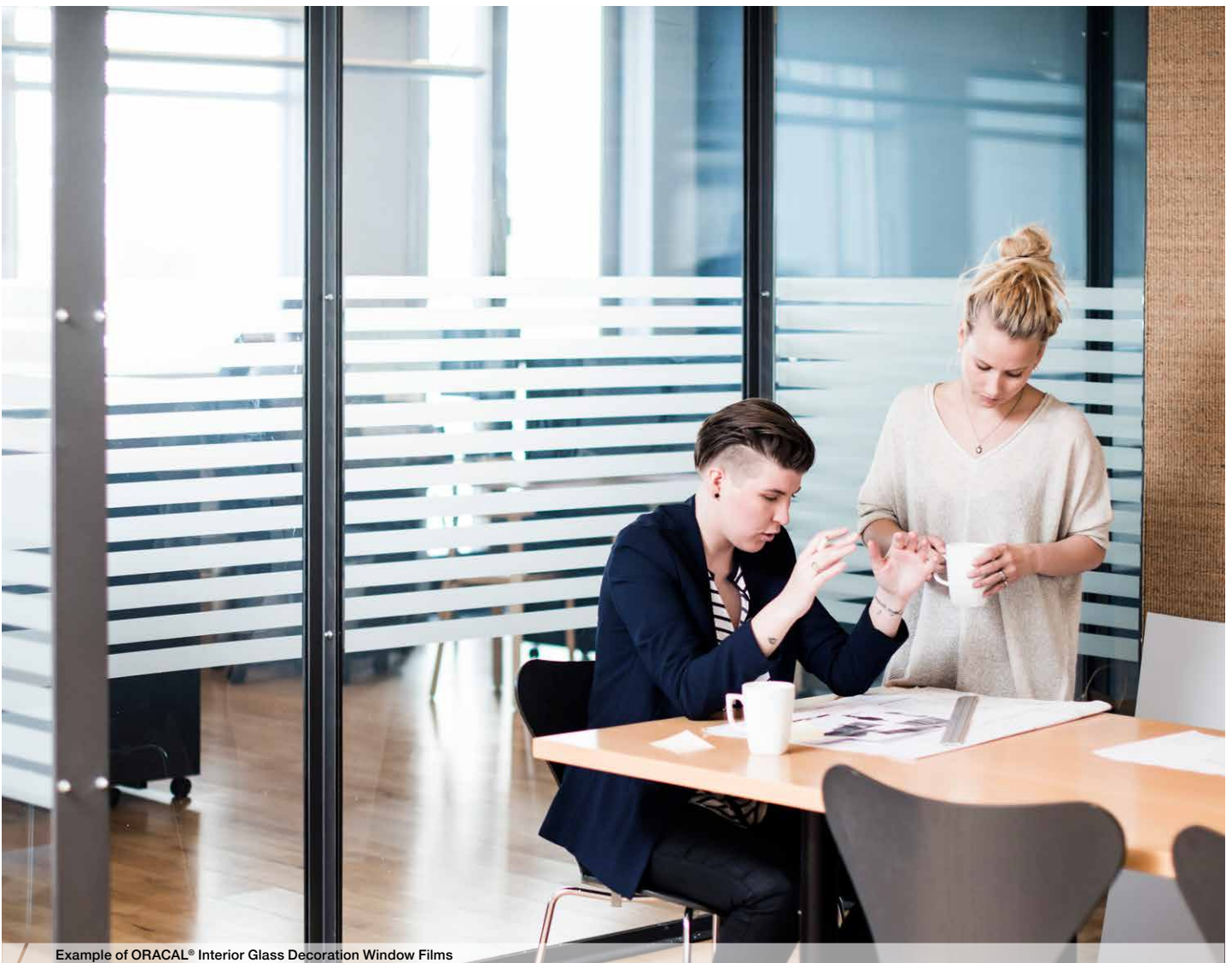

Example of ORACAL® Interior Glass Decoration Window Films

ORACAL Interior Design Window Films: **Choose the pattern and apply!**

Provided with a ready-to-apply decorative patterns, ORACAL Interior Design Window Films offer budget friendly decorative solutions. It is now easier to create different designs!

White stripes of 4mm, Interior Design Window Film

ORACAL® W001

Product Features:

- White Stripes of 4mm
- 38 micron, PET film
- Acrylic copolymer adhesive
- Roll size: 1525mm x 30m
- Expected service life: 5 years
- Wet application is recommended.

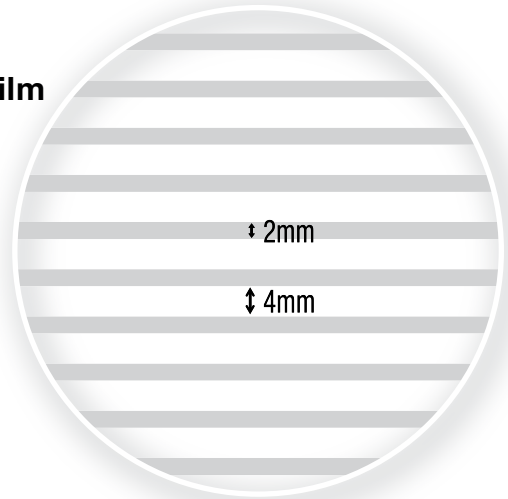

Example of ORACAL® Interior Glass Decoration Window Films

White Squares of 20mm, Interior Design Window Film

ORACAL® W014

Product Features:

- White Squares of 20mm
- 38 micron, PET film
- Acrylic copolymer adhesive
- Roll size: 1525mm x 30m
- Expected service life: 5 years
- Wet application is recommended.

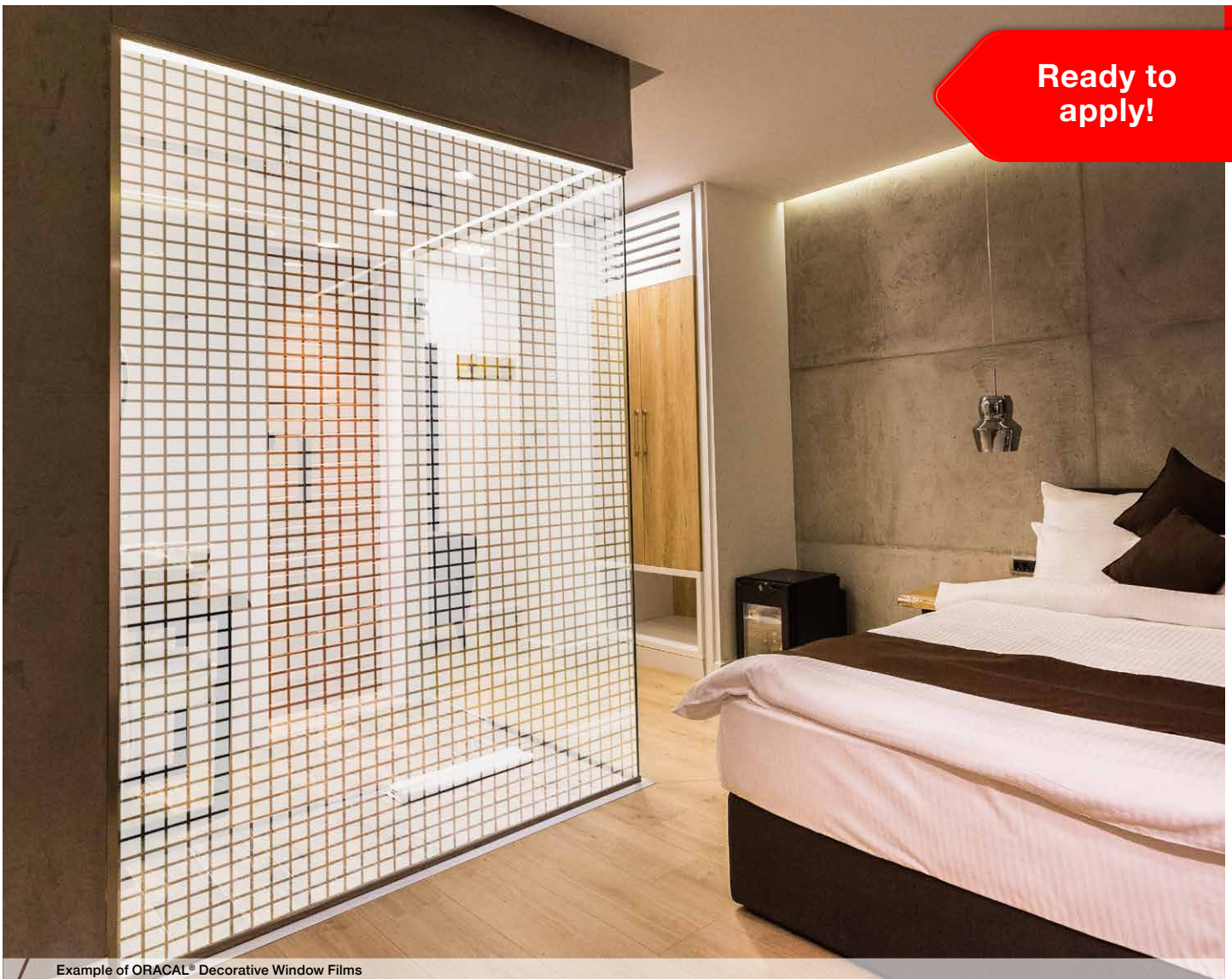
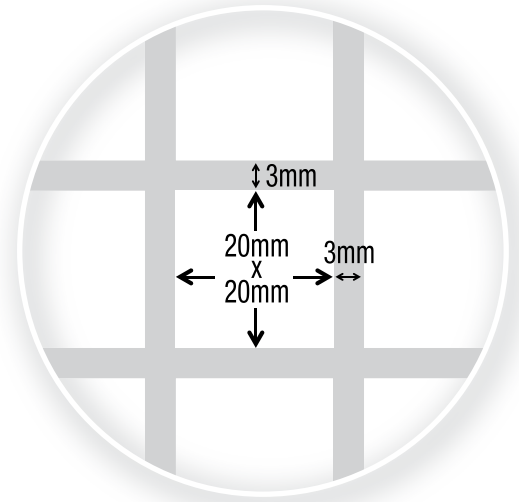

Example of ORACAL® Decorative Window Films

Frosted stripes of 35mm, Interior Design Window Film

ORACAL[®] UV05

Product Features:

- Frosted stripes of 35mm
- 38 micron, PET film
- Acrylic copolymer adhesive
- Roll size: 1525mm x 30m
- Expected service life: 5 years
- Wet application is recommended.

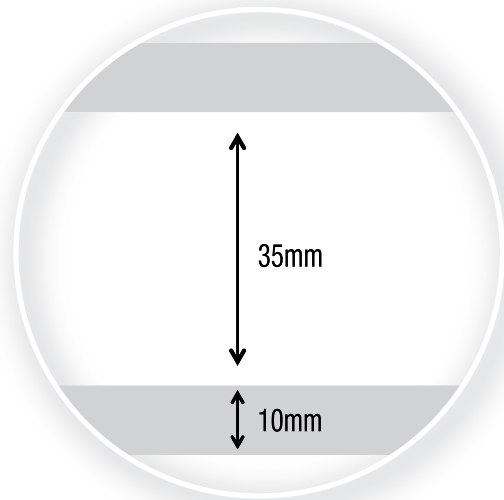

Example of ORACAL[®] Decorative Window Films

Grey stripes of 10mm, Interior Design Window Film

ORACAL® G002

Product Features:

- Grey Stripes of 10mm
- 38 micron, PET film
- Acrylic copolymer adhesive
- Roll size: 1525mm x 30m
- Expected service life: 5 years
- Wet application is recommended

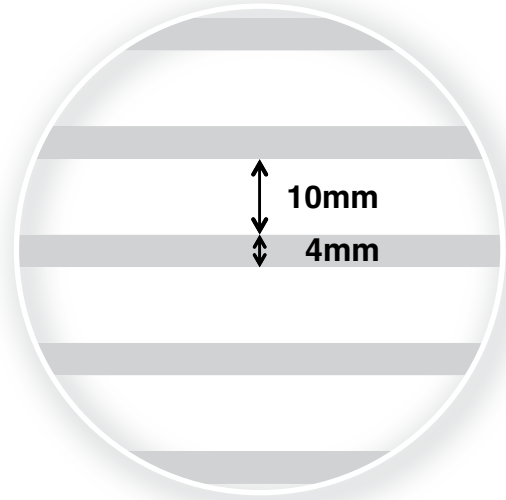

Example of ORACAL® Interior Glass Decoration Window Films

White stripes of 10mm, Interior Design Window Film

ORACAL® W002

Product Features:

- White stripes of 10mm
- 38 micron, PET film
- Acrylic copolymer adhesive
- Roll size: 1525mm x 30m
- Expected service life: 5 years
- Wet application is recommended.

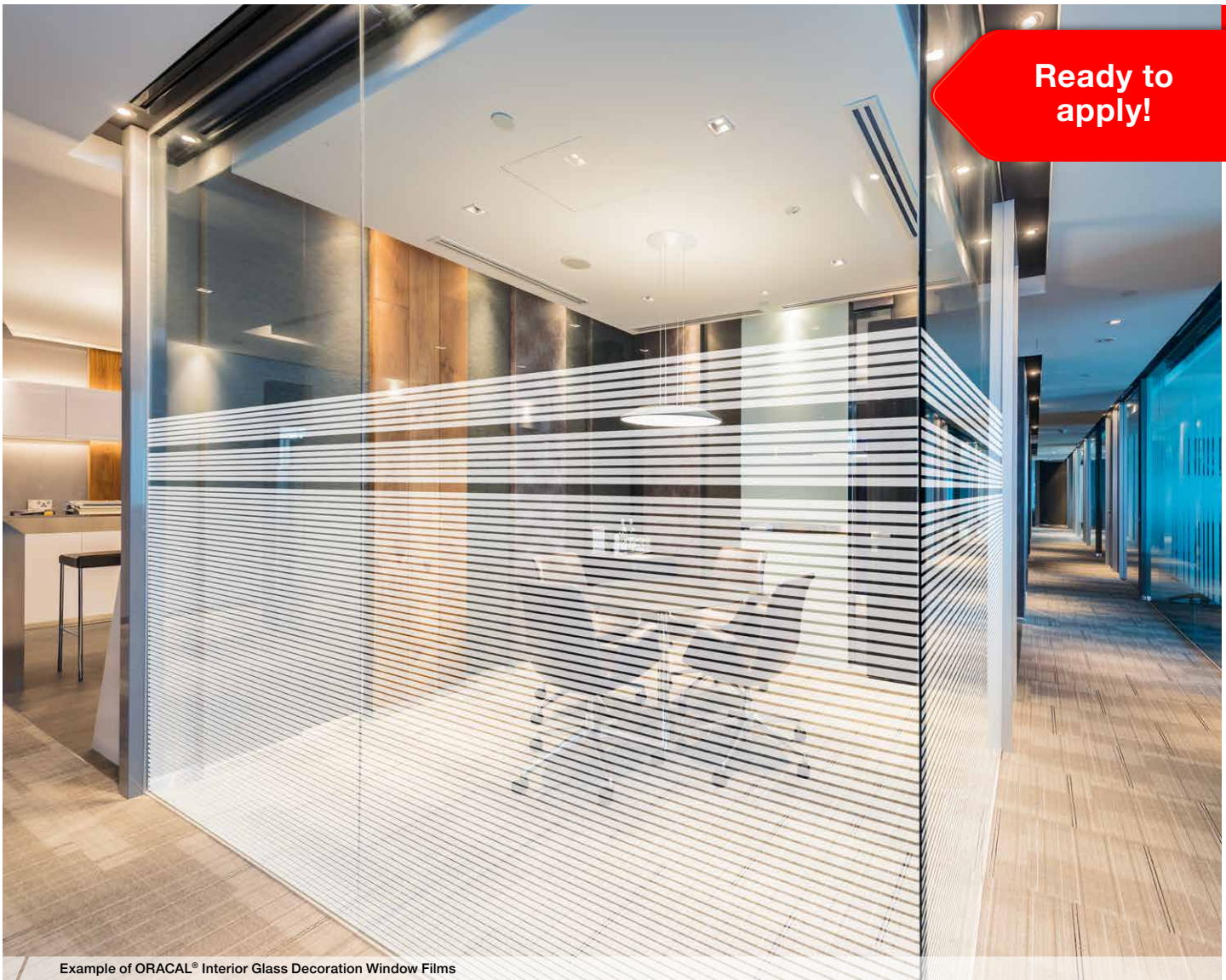
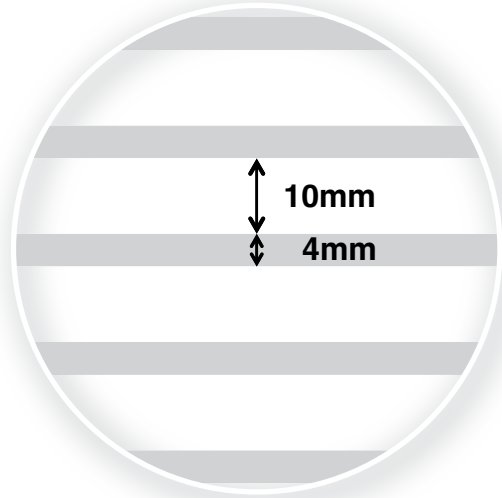

Example of ORACAL® Interior Glass Decoration Window Films

White Cocoon, Interior Design Window Film

ORACAL® W018

Product Features:

- White Cocoon design
- 38 micron, PET film
- Acrylic copolymer adhesive
- Roll size: 1525mm x 30m
- Expected service life: 5 years
- Wet application is recommended.

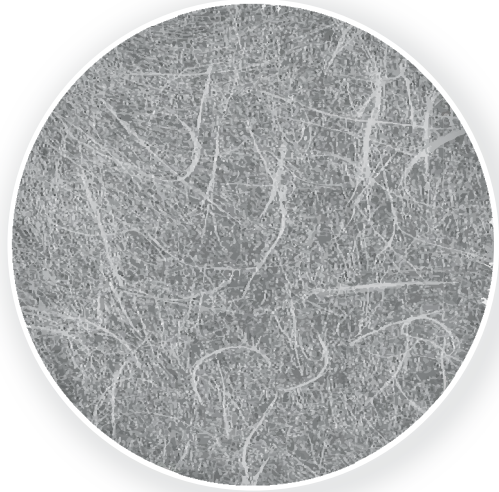

Example of ORACAL® Interior Glass Decoration Window Films



**Ready to
apply!**

White stripes of 30mm, Interior Design Window Film

ORACAL® W004

Product Features:

- White stripes of 30mm
- 38 micron, PET film
- Acrylic copolymer adhesive
- Roll size: 1525mm x 30m
- Expected service life: 5 years
- Wet application is recommended.

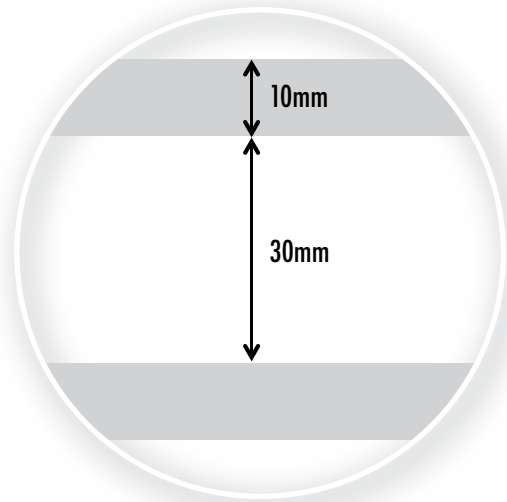

Example of ORACAL® Interior Glass Decoration Window Films

Frosted stripes of 5mm and 35mm, Interior Design Window Film

ORACAL® UV10

Product Features:

- Frosted stripes of 5mm and 35mm
- 38 micron, PET film
- Acrylic copolymer adhesive
- Roll size: 1525mm x 30m
- Expected service life: 5 years
- Wet application is recommended.

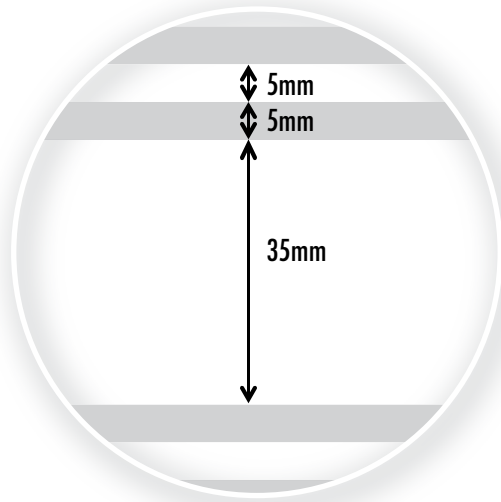

Example of ORACAL® Interior Glass Decoration Window Films

Frosted Squares of 44mm, Interior Design Window

ORACAL® UV11

Product Features:

- Frosted Squares of 44mm
- 38 micron, PET film
- Acrylic copolymer adhesive
- Roll size: 1525mm x 30m
- Expected service life: 5 years
- Wet application is recommended.

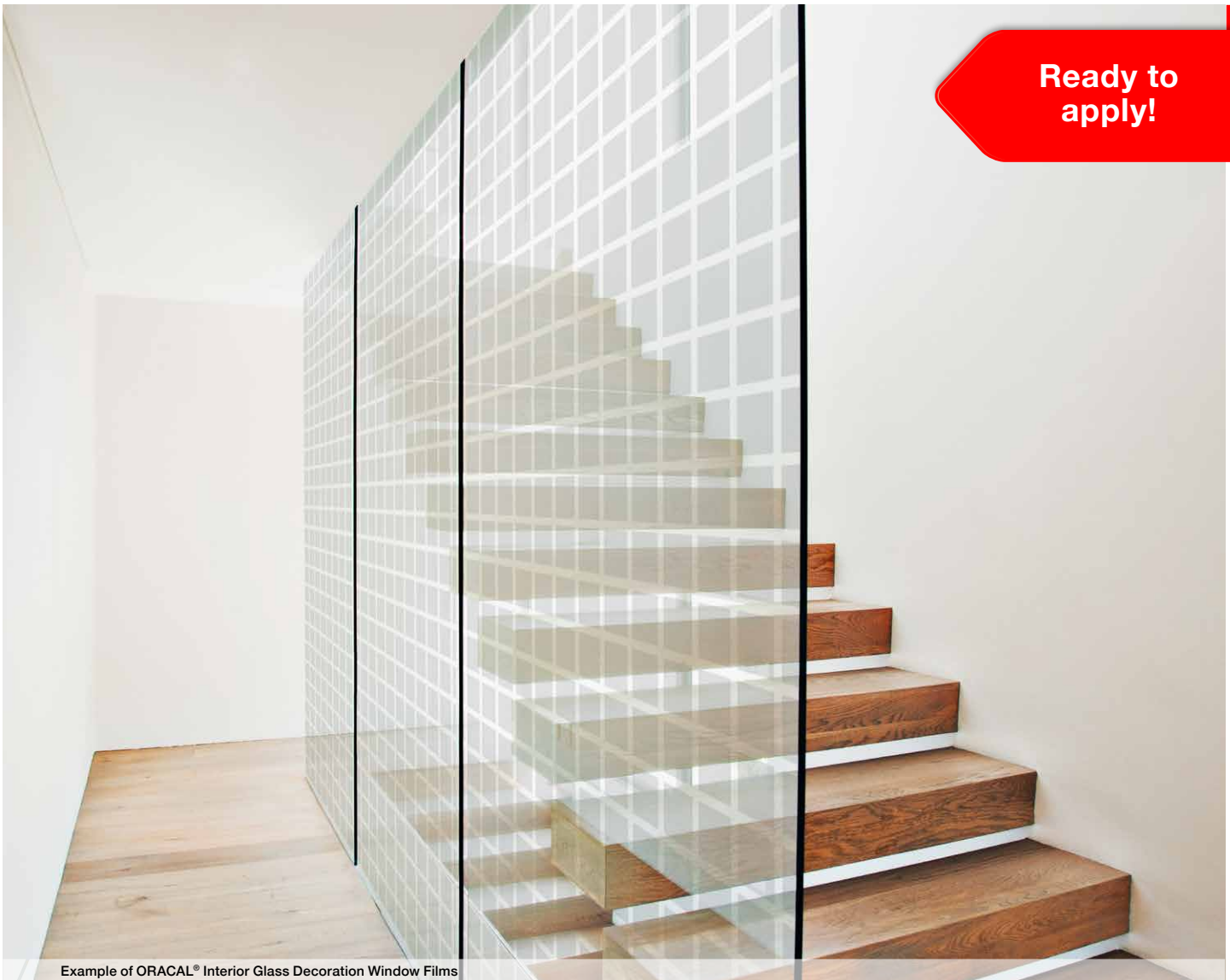
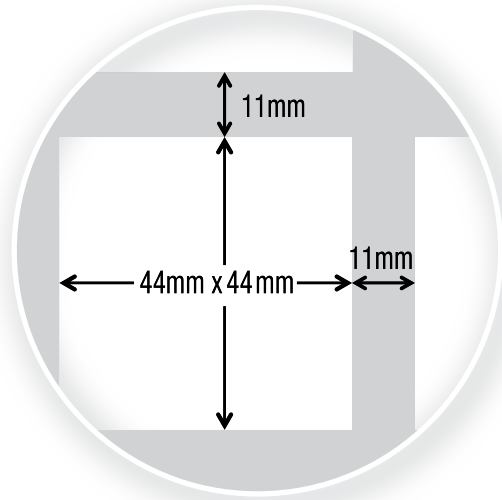

Ready to apply!

Example of ORACAL® Interior Glass Decoration Window Films

White Matt, Interior Design Window Film

ORACAL® WM20

Product Features:

- White Matt
- 38 micron, PET film
- Acrylic copolymer adhesive
- Roll size: 1525mm x 30m
- Expected service life: 5 years
- Wet application is recommended.



Example of ORACAL® Interior Glass Decoration Window Films

Glass Decoration

NEW!**Casual White, Interior Design Window Film**

ORACAL® DX01

Product Features:

- Vertical white lines
- 50 micron, PET film
- Acrylic copolymer adhesive
- Roll size: 1270 / 1525mm x 30m
- Expected service life: 5 years
- Wet application is recommended

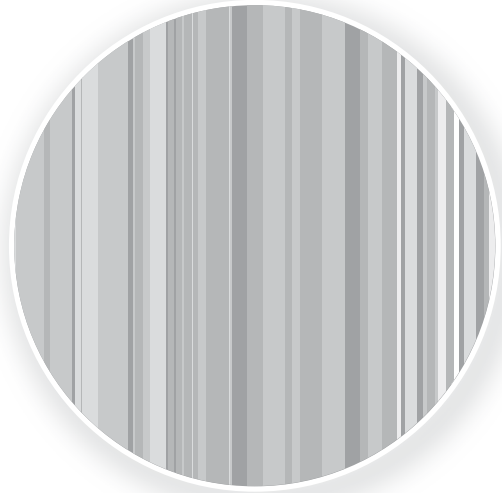
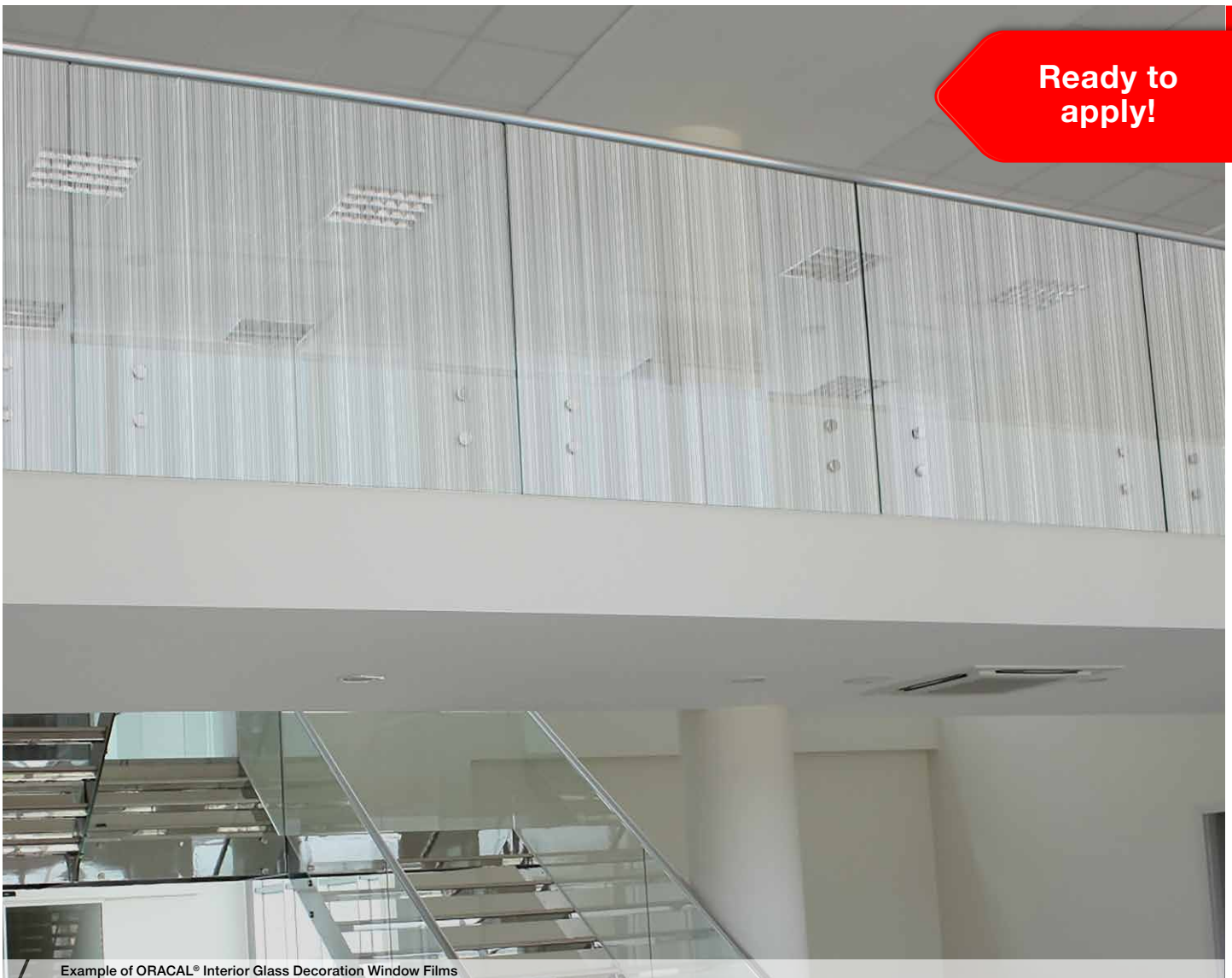
**Ready to apply!**

Example of ORACAL® Interior Glass Decoration Window Films

Glass Decoration

NEW!

White Web, Interior Design Window Film

ORACAL® DX02

Product Features:

- White Grids
- 50 micron, PET film
- Acrylic copolymer adhesive
- Roll size: 1270 / 1525mm x 30m
- Expected service life: 5 years
- Wet application is recommended

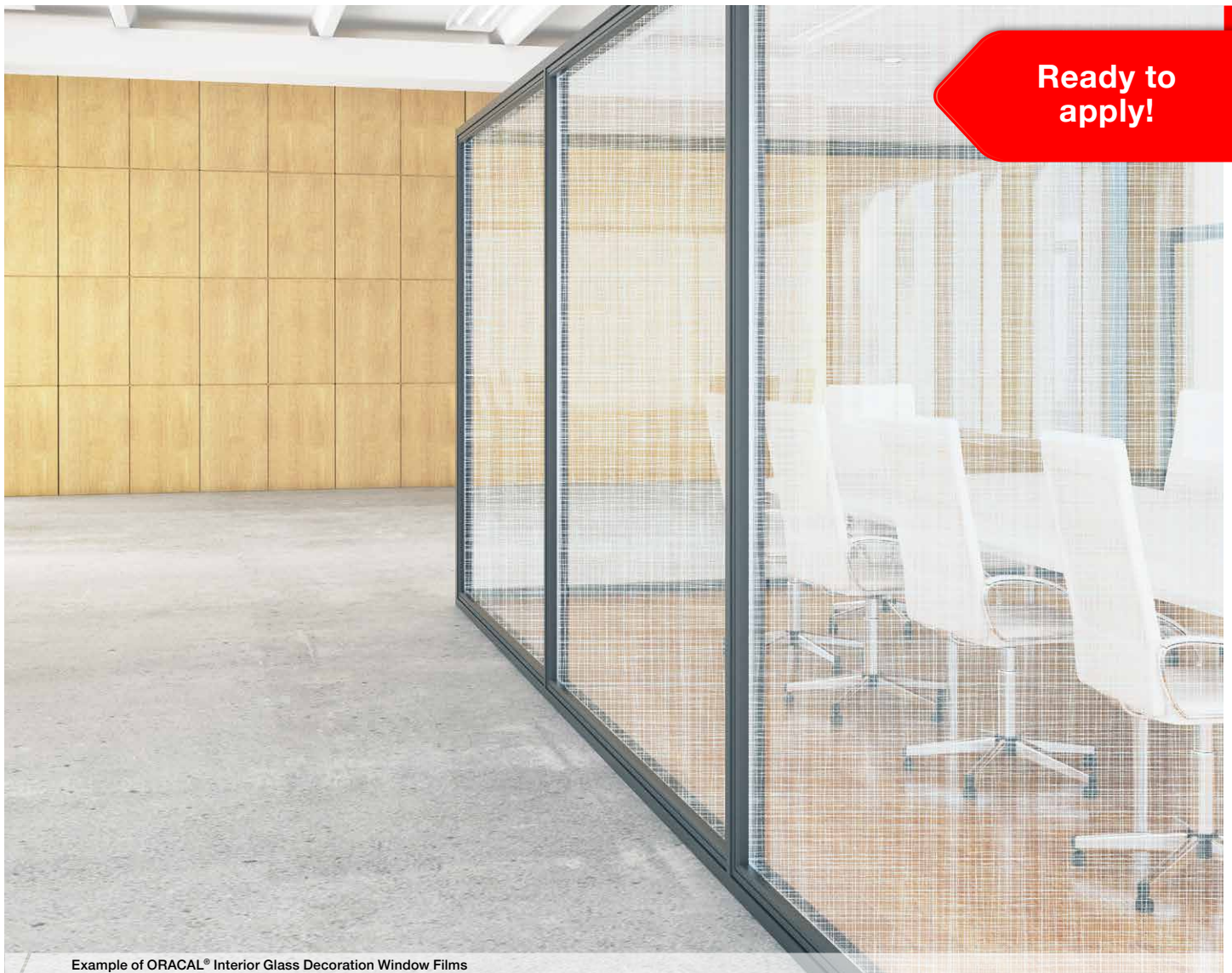

Example of ORACAL® Interior Glass Decoration Window Films

Glass Decoration

NEW!

White Dots, Interior Design Window Film

ORACAL[®] DX03

Product Features:

- White circles of 3mm diameter
- 50 micron, PET film
- Acrylic copolymer adhesive
- Roll size: 1270 / 1525mm x 30m
- Expected service life: 5 years
- Wet application is recommended

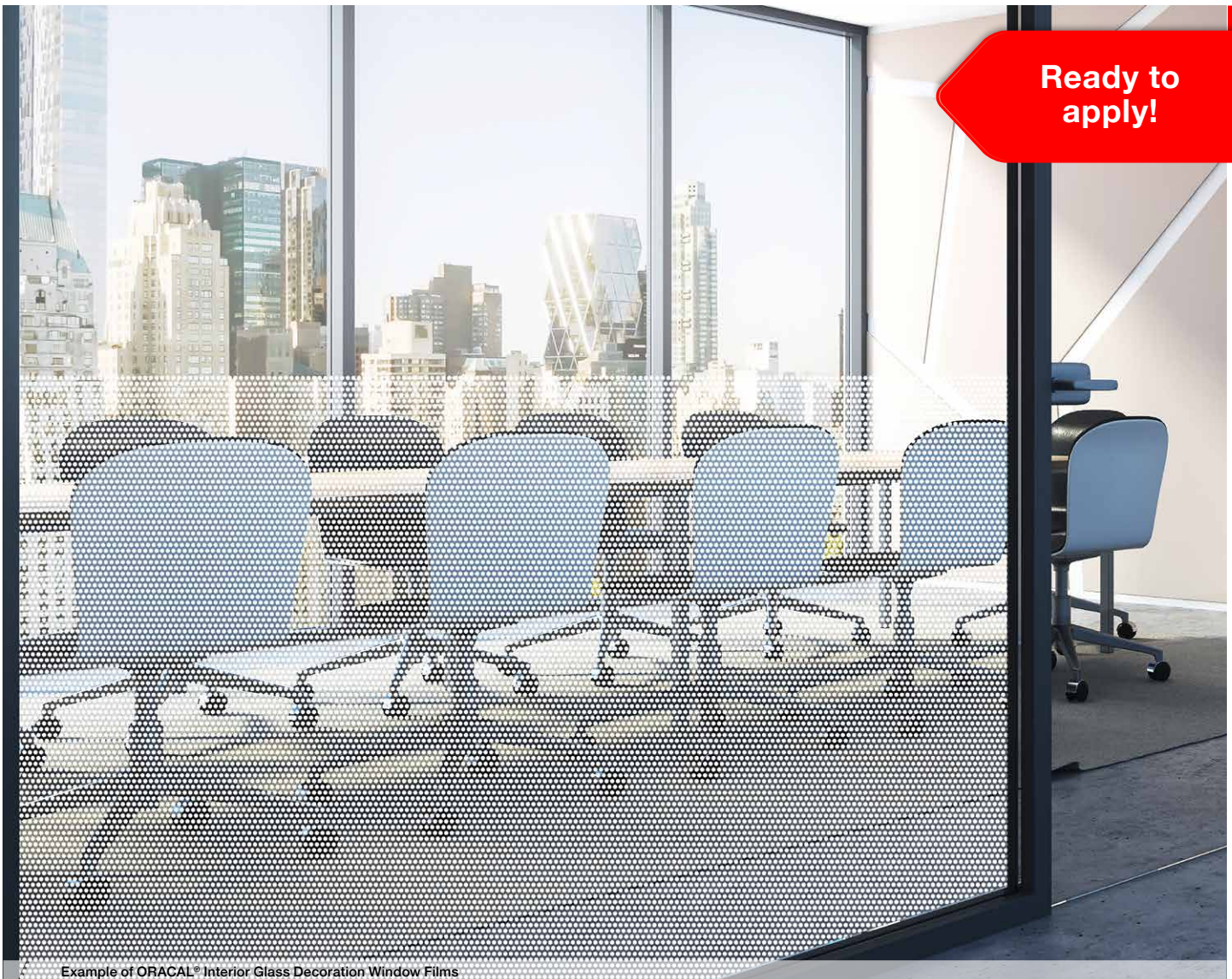
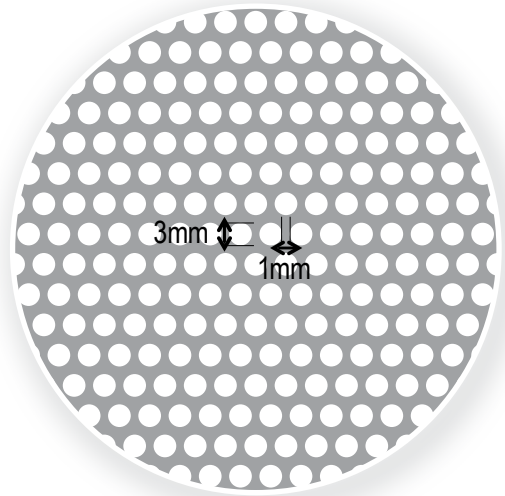

Example of ORACAL[®] Interior Glass Decoration Window Films

Glass Decoration

NEW!

Decreasing Dots, Interior Design Window Film

ORACAL® DX04

Product Features:

- Gradient design with white circles
- 50 micron, PET film
- Acrylic copolymer adhesive
- Roll size: 1270 / 1525mm x 30m
- Expected service life: 5 years
- Wet application is recommended

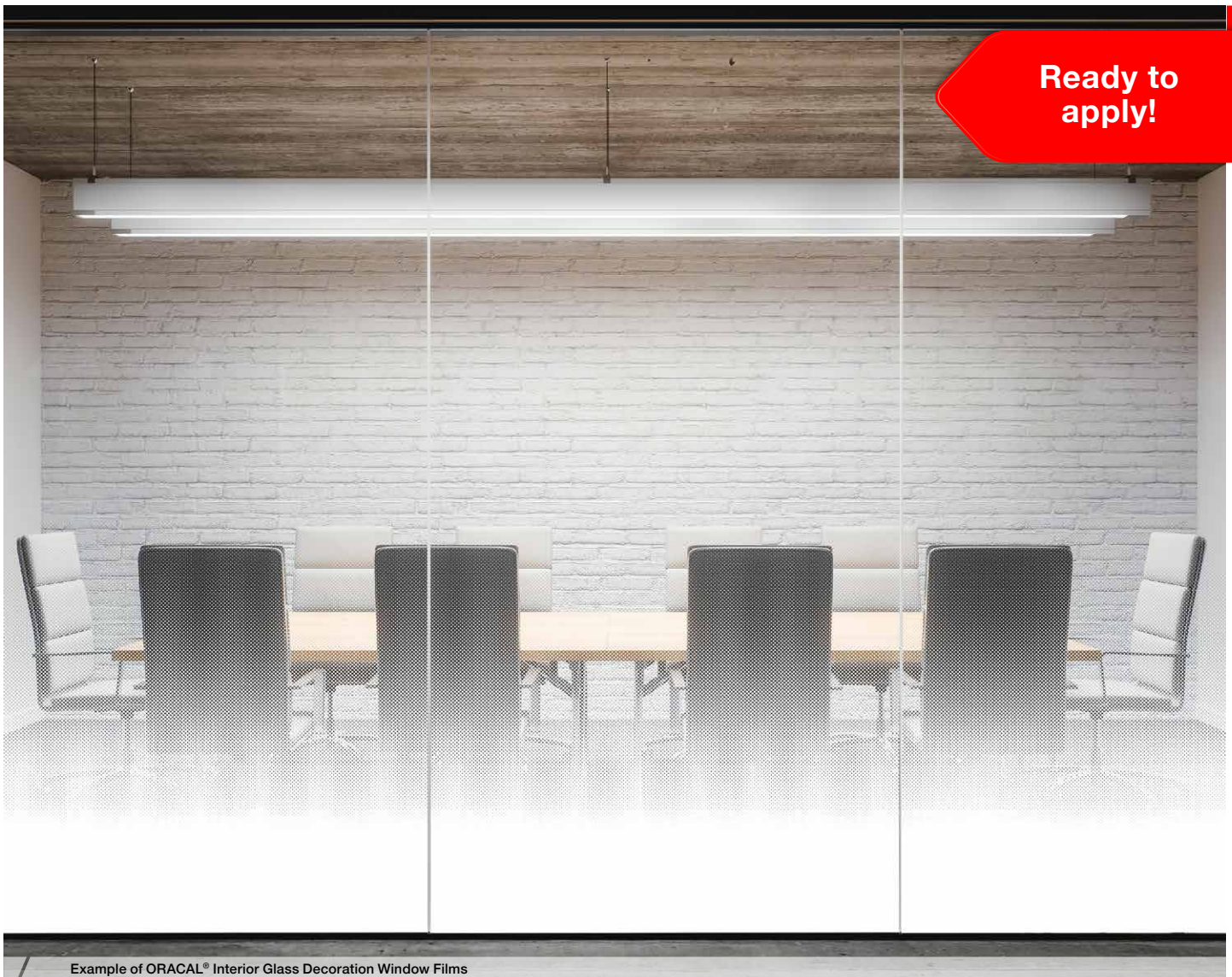
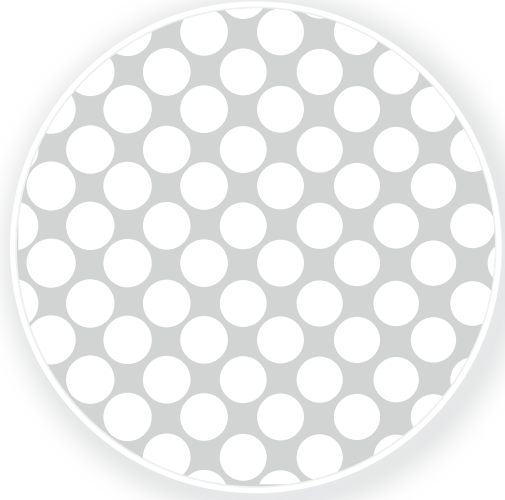

Example of ORACAL® Interior Glass Decoration Window Films

Glass Decoration

NEW!

Gradient Dots, Interior Design Window Film

ORACAL® DX05

Product Features:

- Gradient design with vertical lines of white dots
- 50 micron, PET film
- Acrylic copolymer adhesive
- Roll size: 1270 / 1525mm x 30m
- Expected service life: 5 years
- Wet application is recommended

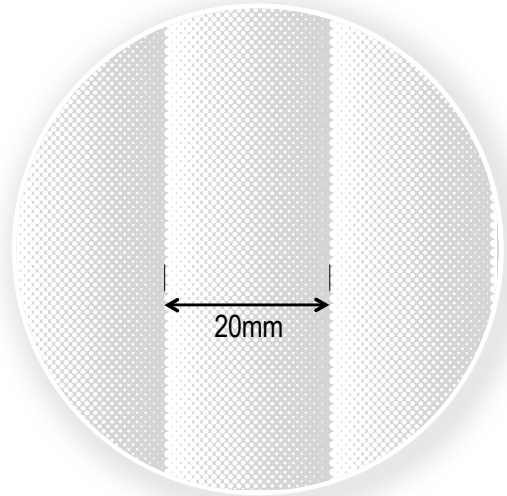

Example of ORACAL® Interior Glass Decoration Window Films

Glass Decoration

NEW!

White & Grey Diamonds, Interior Design Window Fil

ORACAL® DX06

Product Features:

- White & grey quadrilaterals with diamond appearance
- 50 micron, PET film
- Acrylic copolymer adhesive
- Roll size: 1270 / 1525mm x 30m
- Expected service life: 5 years
- Wet application is recommended

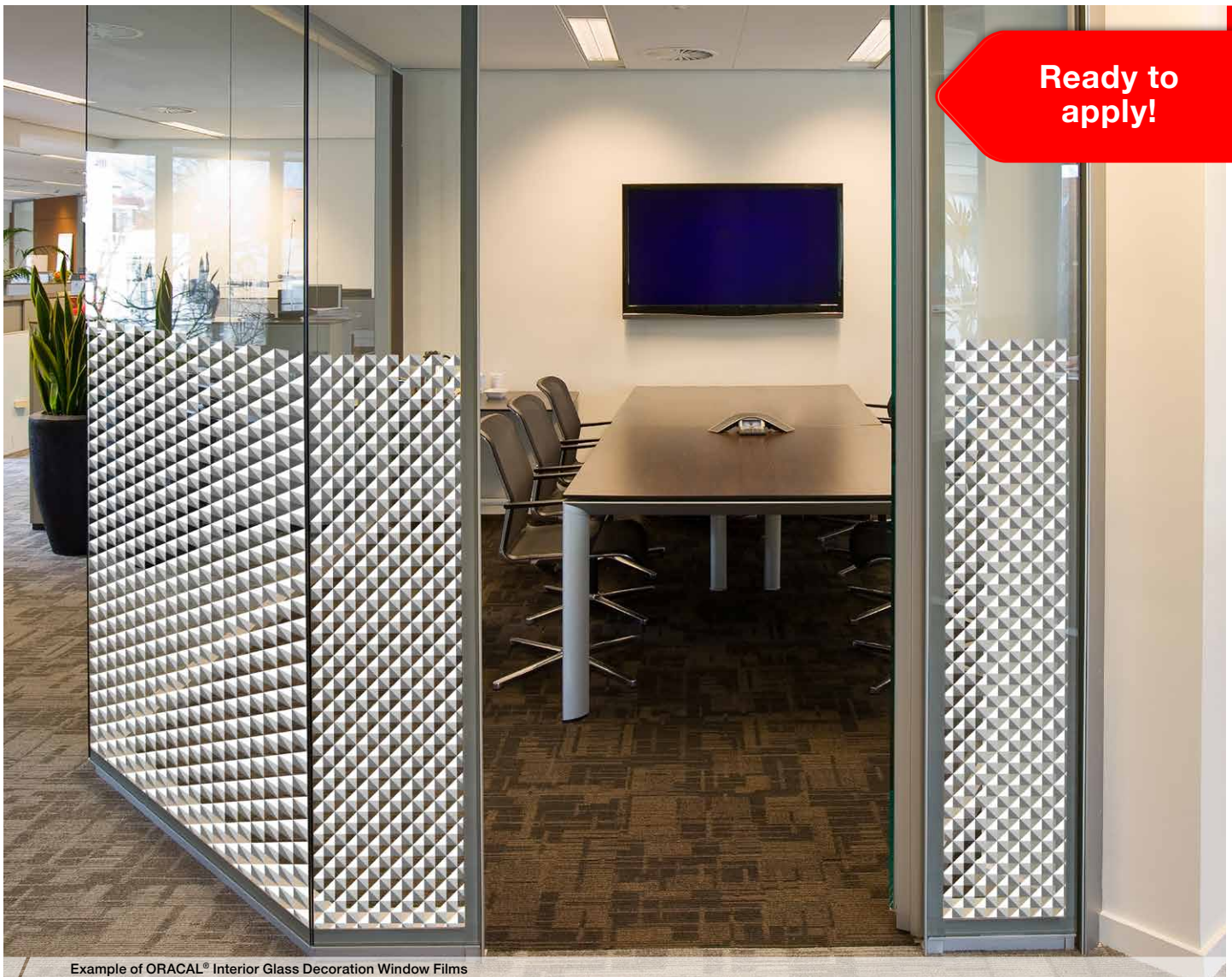
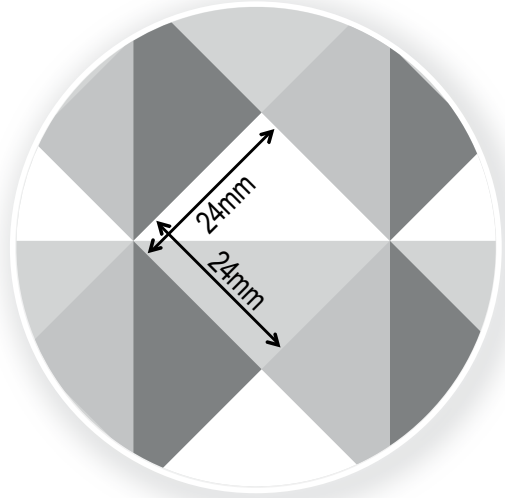

Example of ORACAL® Interior Glass Decoration Window Films

Transparent Cal

ORACAL® 8300

Transparent film in 32 attractive colours for indoor and outdoor decorative design use on glass and plexiglass, especially for window graphics.

Product benefits include:

- Transparent PVC film (80 micron) with UV stabilisers
- 32 glossy colours
- Solvent polyacrylate, permanent, transparent
- Expected service life: 5 years
- Dry and wet application



Example of ORACAL® 8300 Transparent Cal / Photo: Courtesy of Ryerson, USA

Optical Clear Film

ORAJET® 3352F

With the new digital printing film ORAJET® 3352F Optical Clear Film from ORAFOL, installation of glass decorations has never been easier. This optically clear film can be digitally printed, and the printed designs are then installed in full sheets making installation faster and easier than ever. In the areas on the film where there is no print, the ORAJET® 3352F film is so clear that it is hard to even notice the film. The film is suitable for indoor and short-term outdoor application and is easily removable.

Product benefits include:

- Ultra transparent top-coated polyester film (70 micron)
- Available with a glossy surface
- For indoor and short-term outdoor application on windows
- Wet installation possible
- Inkjet printing with solvent based inks, UV- or Latex inks
- Solvent polyacrylate, removable

ORAJET® 3952F

The new ORAJET® 3952F enables easy installation of window graphics. The long term durability of 7 years (not printed) makes it the perfect choice for many window applications. The printed window graphics can be installed in full sheets, making installation faster and easier than ever. In the areas on the film where there is no print, the ORAJET® 3952F is so clear that it is hard to even notice the film. The material is printable with solvent based inks, UV or Latex inks.

Product benefits include:

- Ultra clear, glossy Premium Cast PVC film (50 micron)
- Used for ultra clear colourful advertising and glass decorations, for indoor and long-term outdoor application on windows.
- Recommended: wet application.
- Inkjet printing with solvent based inks, UV- or latex inks
- ORAGUARD® 252F is recommended in combination with 3952F
- Solvent polyacrylate, semi-permanent



Example of ORAJET® 3352F / ORAJET® 3952F

Digital Printing Film

ORAJET® 3851

Digitally printable film for glass decoration

Whether for artistic effect or simply to create privacy, the new ORAJET® 3851 is the perfect modern alternative to traditional etched glass, with its ability to be also digitally printed. The prints will look outstanding with a subtle shimmery look coming from the vinyl. With its long term durability (7 years), it is an ideal choice for applications onto shop windows and glass doors.

The material is printable with solvent based inks or UV inks.

Product benefits include:

- Special PVC film (80 micron)
- Silver grey (fine structure)
- Ideal for indoor and long-term outdoor glass applications
- Wet application is recommended
- Suitable for inkjet printing with solvent and UV inks.
- Solvent polyacrylate, difficult to disassemble
- Expected service life: 7 years (not printed)



Example of ORAJET® 3851

Etched Glass Cal

ORACAL® 8510

Used for decorative design of shop windows and glass doors. Available in gold and silver-grey with hoarfrost effect, or an impression of etched, cut or sandblasted glass.

Product benefits include:

- Polymer PVC film (80 micron)
- Coarse and fine structure
- Wet application is recommended
- Solvent polyacrylate, permanent, transparent
- Expected service life: 7 years

Etched Glass Cal – with *RapidAir*® Technology

ORACAL® 8510RA



RA product benefits also include:

- The *RapidAir*® technology allows a rapid and bubble-free application
- *RapidAir*® requires less application time and cost

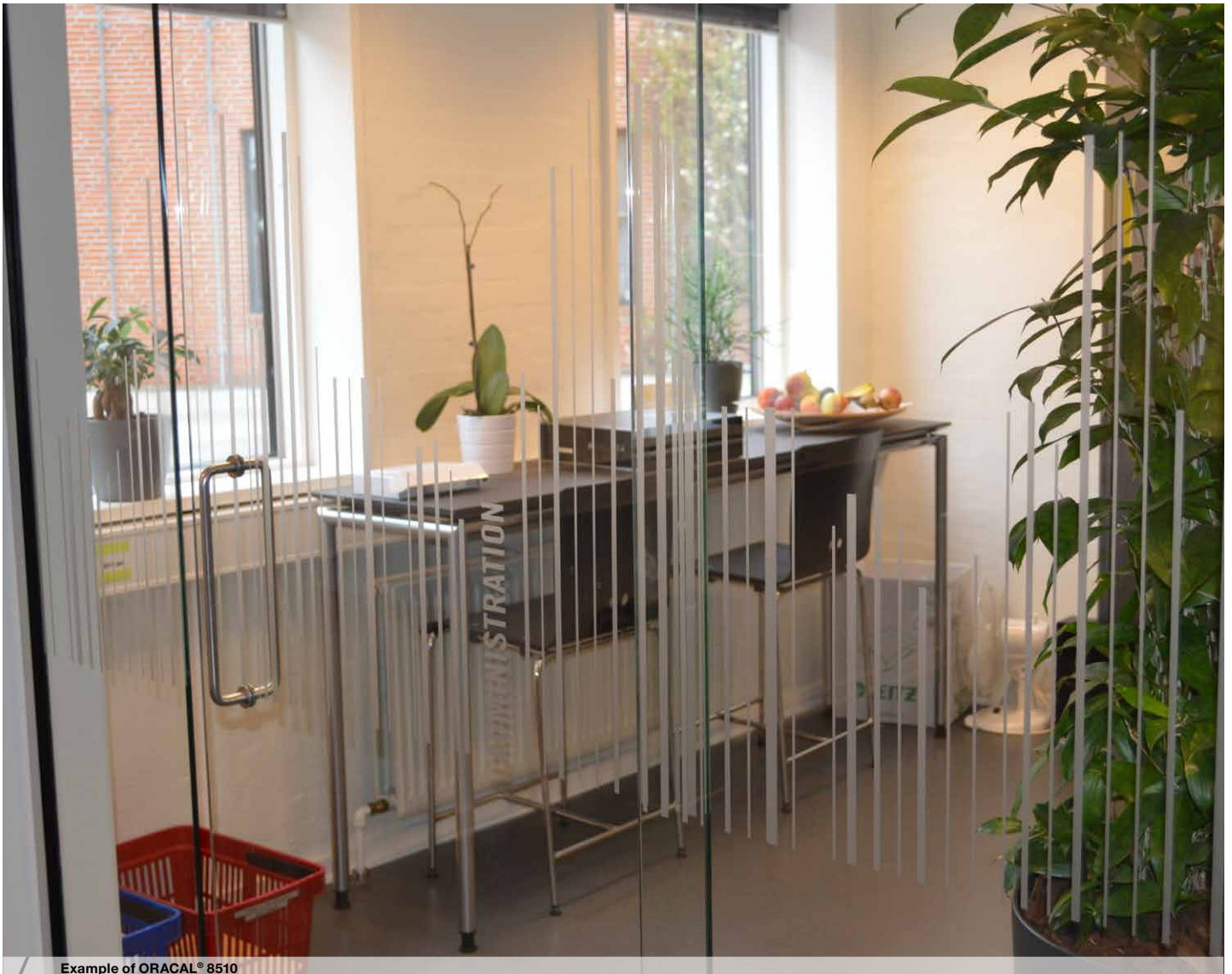

Example of ORACAL® 8510

Etched Glass Cal

ORACAL® 8530

Exceptionally easy to remove

Product benefits include:

- Polymer PVC film (80 micron)
- **Exceptionally easy to remove**
- In silver with hoarfrost effect, or an impression of etched, cut or sandblasted glass (coarse and fine structure)
- For the decorative design of shop windows and glass doors
- Solvent polyacrylate, removable
- Expected service life: 5 years



Example of ORACAL® 8530

Dusted Glass Cal

ORACAL® 8710

Even more possibilities for decorative designs of glass areas, such as shop windows, room dividers and glass doors.

Creates the look of a rough glass surface.



Product benefits include:

- Polymer PVC film (70 micron)
- Medium glossy surface prevents unwanted light reflections
- Wet application is recommended
- Solvent polyacrylate, permanent, transparent
- Expected service life: 7 years



Example of ORACAL® 8710

Frosted Glass Cast

ORACAL[®] 8810

For extra high quality glass decoration of shop windows and glass doors. Five variants available with hoarfrost effect.



Product benefits include:

- Cast high-performance PVC film (80 micron)
- Eye-catching, glamorous glitter effects
- Extreme resistance to weathering and UV
- Wet application is recommended
- Solvent polyacrylate, permanent, transparent
- Expected service life: 7 years

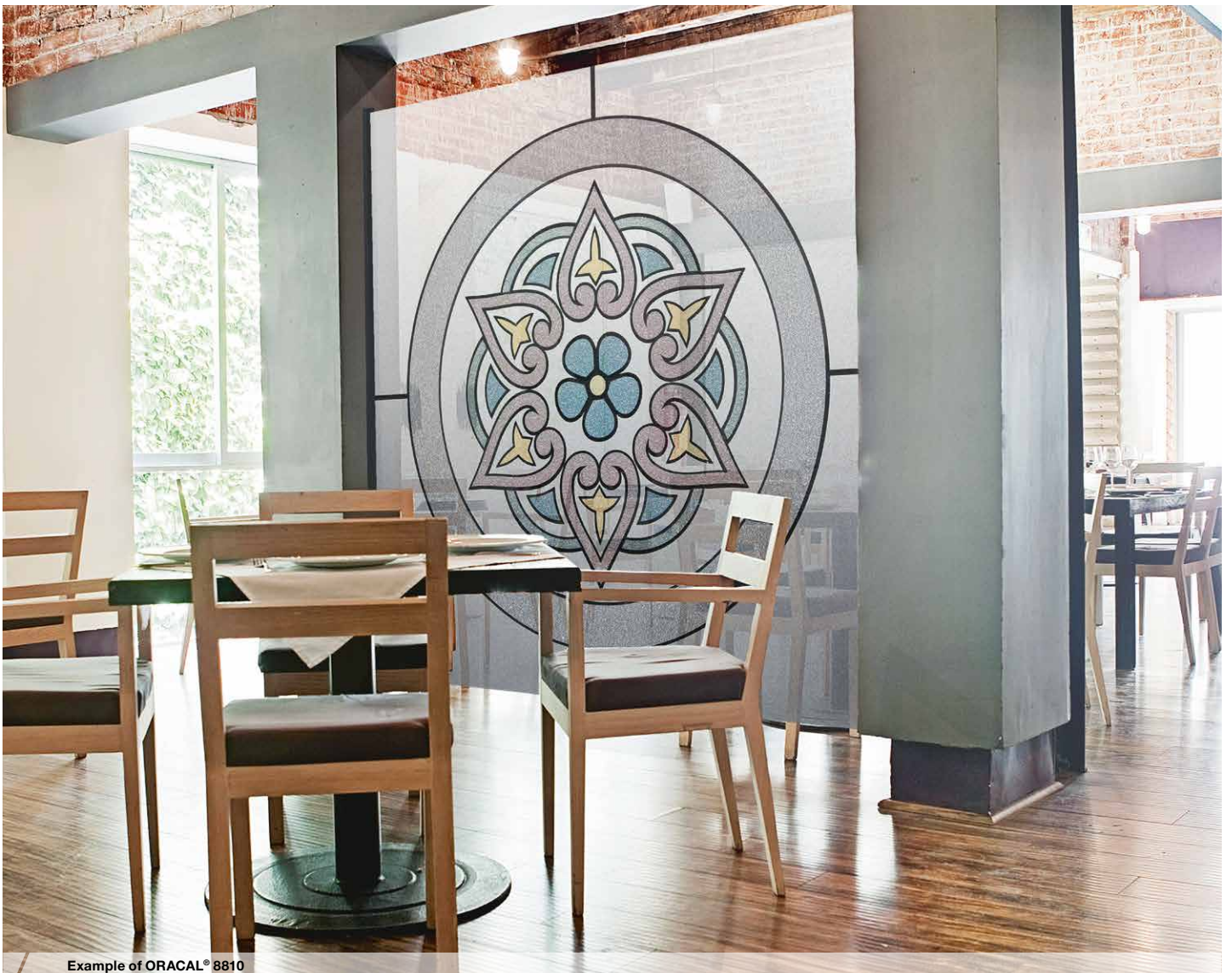

Example of ORACAL[®] 8810



Engineered to Perform Better™

Decorative Window Films

ORAFOL TURKEY

Akçaburgaz Mh. 9. Cd. 117. Sk. No:5 Kıraç / Esenyurt, 34522 İstanbul, Turkey

Tel: +90 212 671 26 83 / info@orafol.com.tr

Find out more about our products at: www.orafol.com.tr

